



**GALVO SHED**  
SIMPLY GREAT STORAGE

# GVO 1508

## SLOPING ROOF SHED

1530mm wide x 780mm deep x 1830mm - 1770mm high

## ASSEMBLY INSTRUCTIONS

### YOU SHOULD HAVE ONE PACKAGE:

- 1 cardboard package

### TOOLS REQUIRED:

- Battery or electric drill
- 3.3mm (1/8th inch) drill bit
- Screwdriver or riveter
- Tape measure
- Ladder
- Non-slip gloves, good shoes and goggles
- A set of helping hands

PACKED BY:



Please quote this code for any correspondence back to the supplier

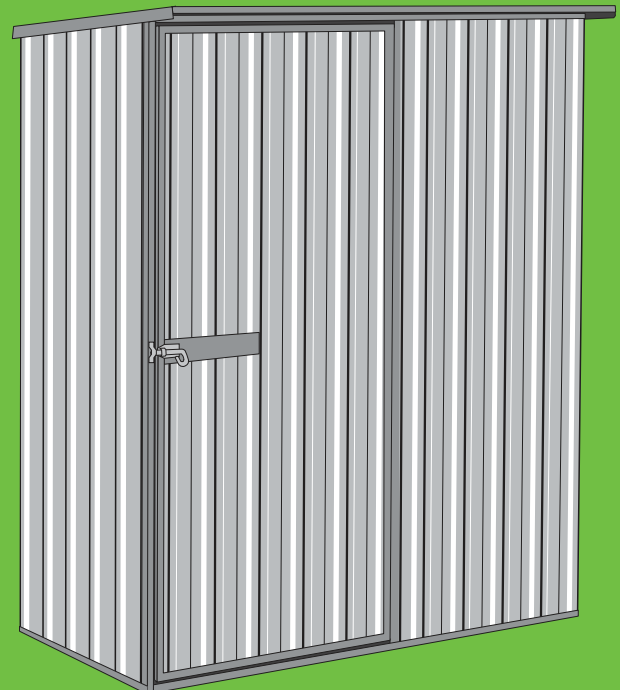

Some parts have sharp edges and should be handled very carefully. We recommend the use of protective gloves and footwear when assembling.

DO NOT attempt to erect this shed in windy weather. All dimensions are approximate.







**KITSET  
ASSEMBLY  
SERVICES**

**CALL 0508 454 873**  
for an installer near you

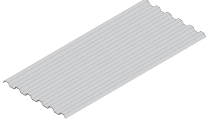
# COMPONENTS CHECKLIST

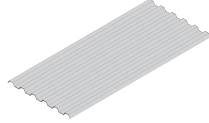
Please check all components carefully and advise your supplier immediately if any discrepancies. Remember to quote the code on the front page.

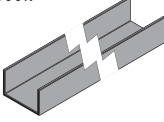
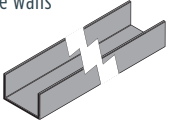
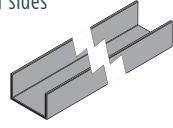
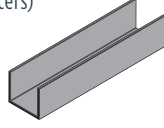
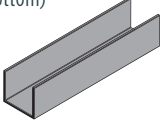
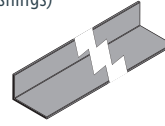
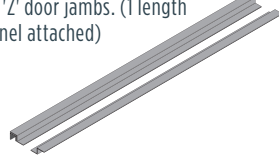
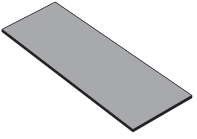
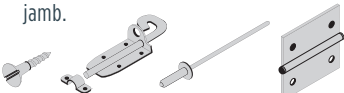
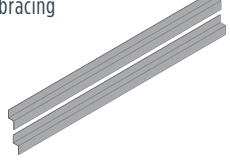
<p><b>A</b> 1 x 1770 x 780mm door sheet</p> 	<p><b>B</b> 1 x narrow 1830 x 715mm sheet for front wall, beside door</p> 	<p><b>C</b> 2 x 1770 x 780mm sheets for back wall</p> 
<p><b>D</b> 2 x 980mm x 780mm sheets for roof</p> 	<p><b>E</b> 2 x 1830 - 1770mm sloping sheets (side walls, 1 left &amp; 1 right)</p> 	<p><b>F</b> 6 x 1515mm 'U' channels for front, back and roof.</p> 
<p><b>G</b> 4 x 735mm 'U' channels for side walls</p> 	<p><b>H</b> 2 x 1770mm 'U' channels for door sides</p> 	<p><b>I</b> 2 x 793mm 'U' channels (door spacers)</p> 
<p><b>J</b> 2 x 780mm 'U' channels (door top and bottom)</p> 	<p><b>K</b> 2 x 980mm 'L' flashings (roof to side flashings)</p> 	<p><b>L</b> 2 x 1830mm 'Z' door jambs. (1 length has 'U' channel attached)</p> 
<p><b>M</b> 1 x 310mm door plate</p> 	<p><b>N</b> 1 x Pack of rivets, 1 x Riveter, 1 x Drill bit and 2 x 'z' door braces per door. And a padbolt pack with wide flanged rivets for fixing the padbolt on to the door and door jamb.</p> 	<p><b>O</b> Door bracing</p> 

## IMPORTANT!

- Remove the swarf (drill filings) from the panels as you assemble them.
- All components are cut to length. Do not cut any parts unless instructed.
- Fixings through the inside of the channels into the sheeting are just as important as fixings from the outside.

## RIBS AND PANS

- Generally most fixings are spaced at 300mm apart.
- Keep the fixings in the pans as close to the ribs as possible for added strength.
- Ribs will always protrude to the outside of the shed.
- Extra internal fixings are strongly recommended in high wind areas.

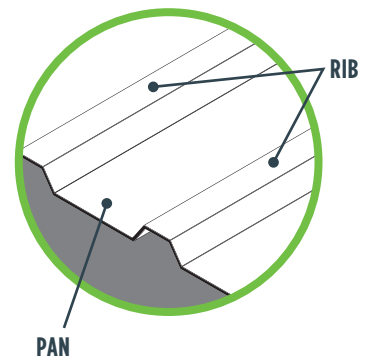

## BUILDING YOUR SHED

- The basic task is to join the sheets together to form your panels, and fix channels to the top and bottom of these panels. They will then join together to form your shed (diagram 1, 2, and 3).

DIAGRAM 1

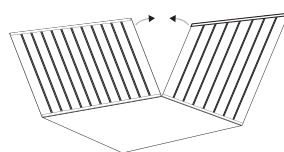

DIAGRAM 2

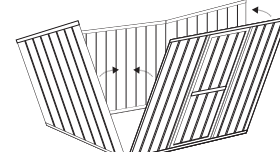
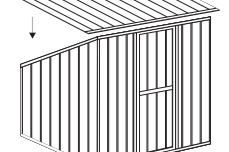

DIAGRAM 3



# STEP 1 DOOR ASSEMBLY

Attach the 780mm 'U' channels **J** to the top and bottom of the door sheet **A** at the centre ribs only. Attach the 1770mm 'U' channels **H** to the door sheet **A** through the top and bottom channels **J** at the four corners. Attach the door plate **M** in the centre of the door sheet, slipping it under the two side 'U' channels and fixing it to the sheet ribs and the side 'U' channels. Attach the hinges **N** approx 150mm from the top and bottom of the door through the 'U' channels. The fixings should be centred on the side 'U' channels.

Turn the door over and fix the four corners through all the 'U' channels (step 2 below). Fit the door bracing from the bottom corner to the opposite centre to the top corner (see step 7 on page 6).

## YOU WILL NEED

- A** 1 x 1770 x 780mm door sheet
- H** 2 x 1770mm 'U' channels for door sides
- J** 2 x 780mm 'U' channels (door top and bottom)
- M** 1 x 310mm door plate
- N** Hinges
- O** Door bracing

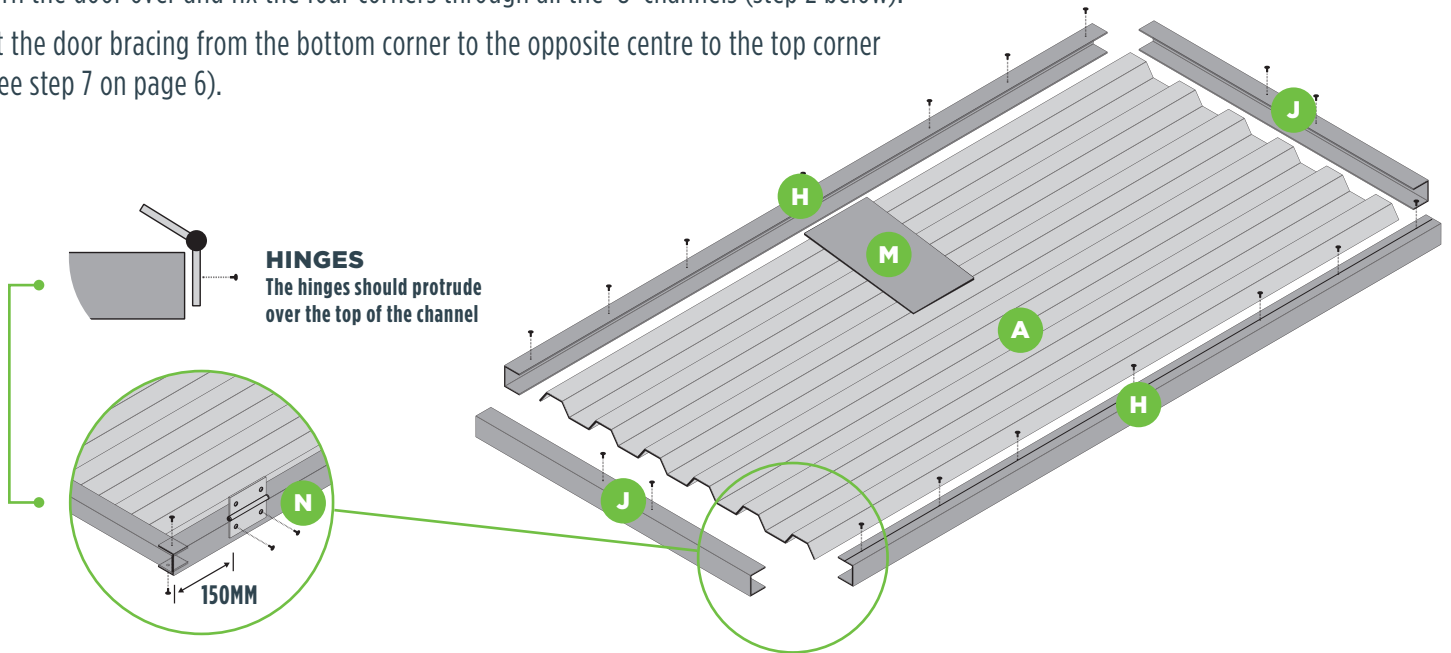

# STEP 2 HANGING THE DOOR

Attach the first 'Z' door jamb **L** to the 715mm sheet **B** on the rib with the narrow pan. Lay the premade door face down on the 715mm sheet **B** approx 30mm up from the bottom and down from the top. Check the door is centralised on the sheet (top and bottom). Fix the hinges through the side of the 'Z' door jamb **L** raising the door about 4mm off the 'Z' door jamb.

## YOU WILL NEED

- B** 1 x 1830 x 715mm sheet for front wall
- L** 1830mm 'Z' door jambs without channel attached

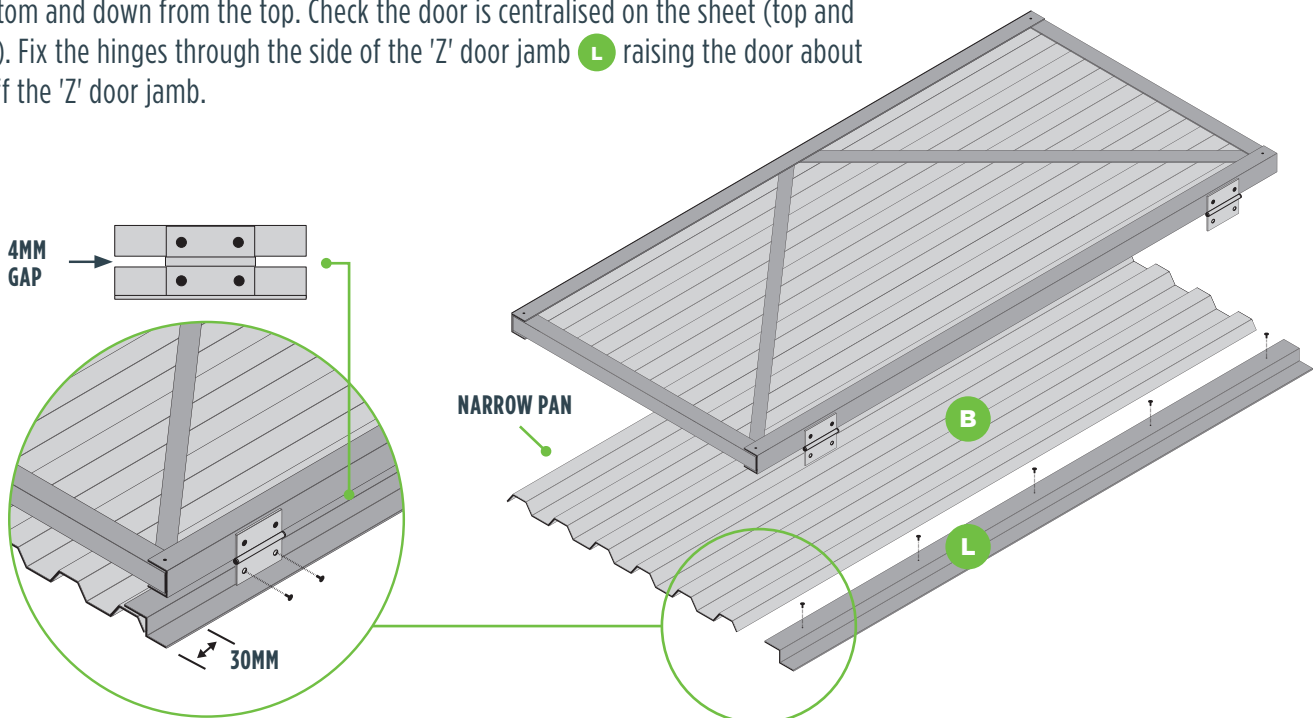

# STEP 3 FRONT WALL

Lay out the door with the sheet attached and the corner door jamb with the 'U' channel attached (as shown below). Cap the sheets with the 1515mm channels **F**. Use the door spacers **F** to make sure the door fits the gap (they sit on top of the 'Z' door jambs **L**). Drill and fix the channels at every second rib down through the top.

Attach the door spacers at each end through the 'Z' door jambs and channels. Put three fixings underneath through the channels into the sheeting pan and the top and bottom of the door spacers and 'Z' door jambs (see diagram 1).

Fit the padbolt to the door strap on the outside of the door using wide flange fixings or screws. **(We recommend you use an 8mm shackle diameter padlock on these pad bolts, anything smaller may create security issues.)**

## YOU WILL NEED

- F** 2 x 1515mm 'U' channels
- I** 2 x 793mm door spacers
- B** 1 x 1830mm x 715mm sheet
- L** 'Z' door jambs (attached to B)
- N** Padbolt

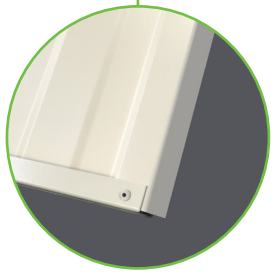
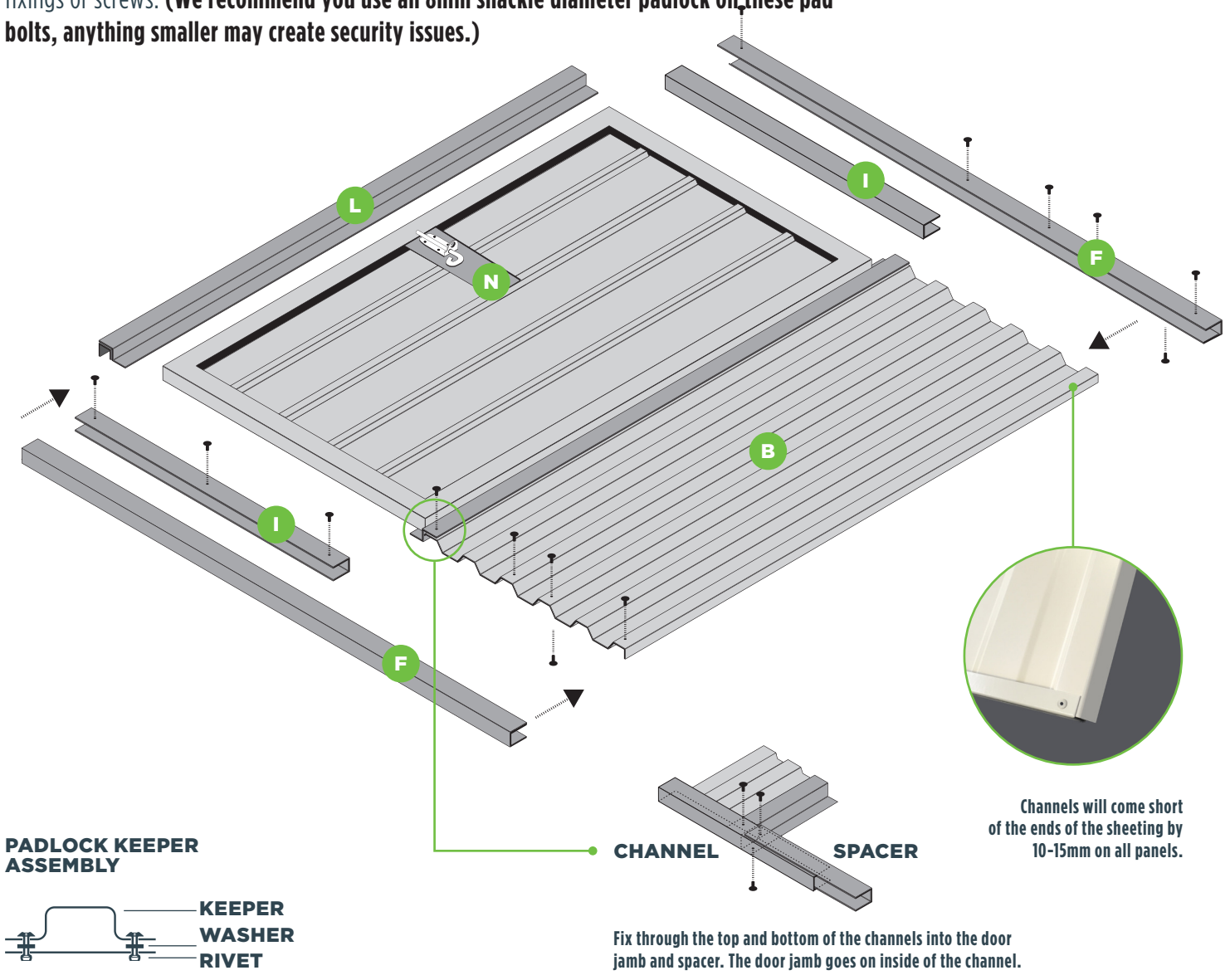

Channels will come short of the ends of the sheeting by 10-15mm on all panels.

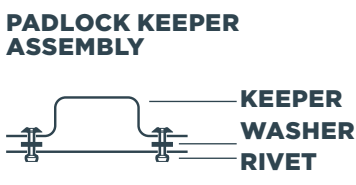

## ADDITIONAL INFORMATION

**CHANNELS**  
The higher side of the channel goes to the inside of the shed. It is very important to include the fixings on the underside of all the channels as they are structural (except roof channels).

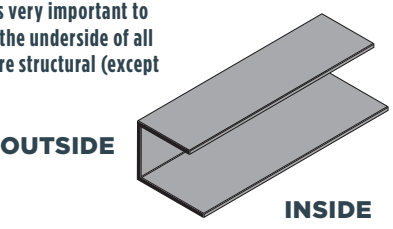

**GALVO TIP**  
To hinge the door on the opposite side, simply put the top channel on the bottom and the bottom on the top.  
Put the padbolt on the door before erecting the panels. It will stop the door swinging around!

## STEP 4 BACK WALL

Join the two sheets **C** together with 2 fixings through the overlapping ribs, making sure the ends of the sheets are flush. Cap the sheeting with the 1515mm 'U' channels **F**.

Fix the channels through the end ribs and every second rib in between. Make sure you put at least one fixing per sheet up through the underside of the channel into the pan of the sheet.

### YOU WILL NEED

- C** 2 x 1770 x 780mm sheets
- F** 2 x 1515mm 'U' channels

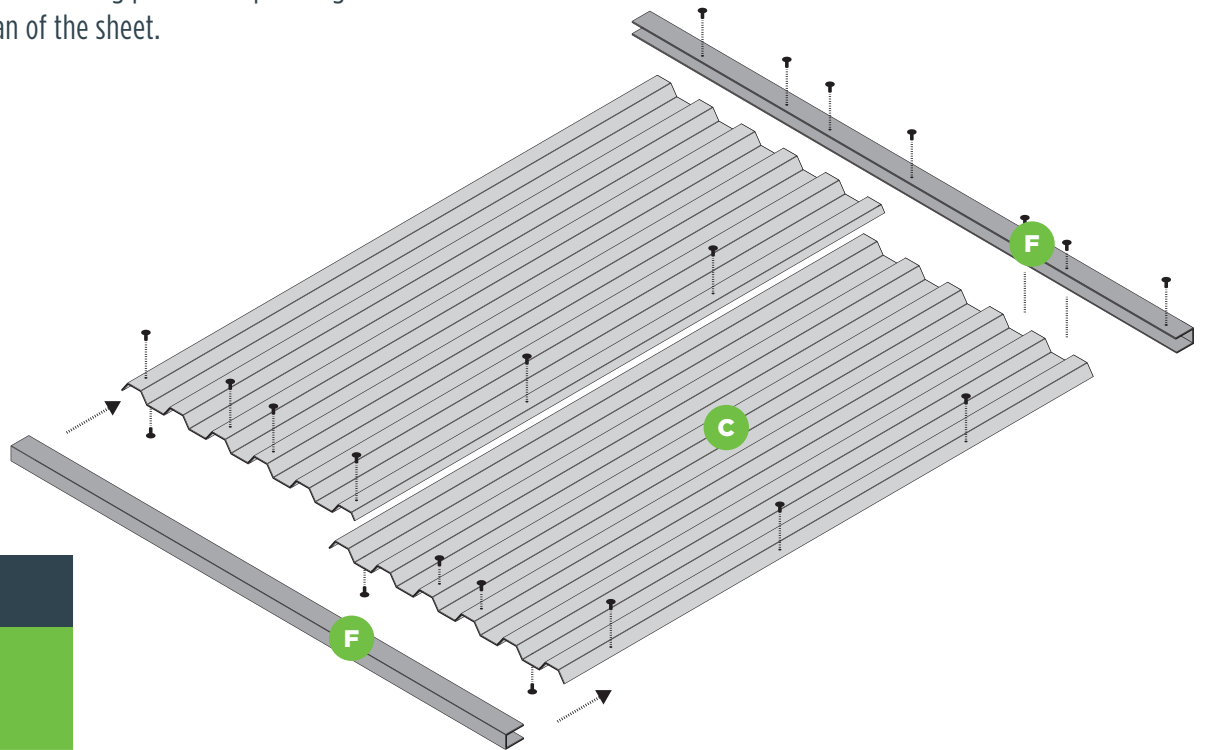

### GALVO TIP

Put extra fixings in for high wind areas, particularly on the underside.

## STEP 5 ROOF

Join the two sheets **D** together, same as the back. Cap the sheeting with the 1515mm 'U' channels **F**. Fix the channels at every second rib but not the corners at this stage.

Place the short flange of the first 'L' flashing **K** on top of the rib at one end.

Make sure the ends are flush with the sheeting (diagram 1) and put one fixing in the centre to hold the 'L' flashing. Fix the corners through the channels and one more between the corner and the centre fixing. Perform the same at the other end.

Use five fixings in each 'L' flashing.

### YOU WILL NEED

- D** 2 x 980mm x 780mm sheets
- F** 2 x 1515mm 'U' channels for the roof
- K** 2 x 980mm 'L' flashings

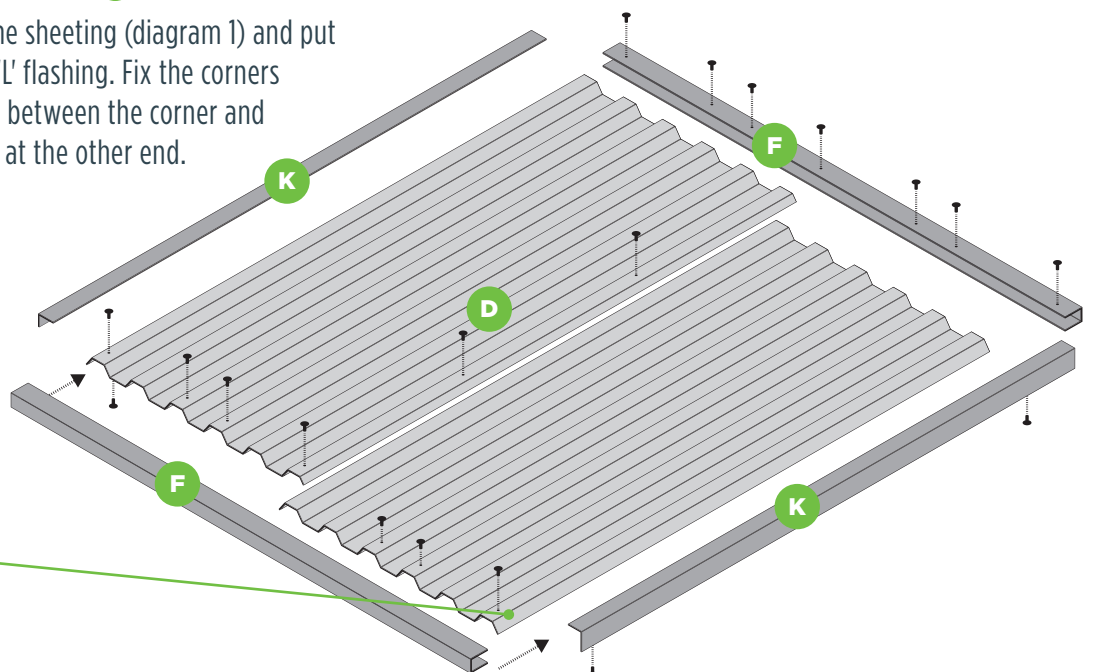
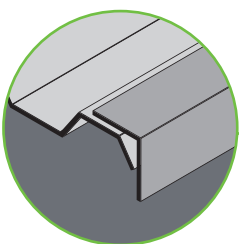

DIAGRAM 1



## STEP 6 END WALLS

Cap the sloping sheets **E** with the 735mm 'U' channels **G**.

Fix the channels through the end ribs and every second rib in between.

Make sure you put at least two fixings up through the underside of the channel into the pan of the sheet.

Repeat for other side wall with opposite slope.

### YOU WILL NEED

**E** 2 x 1830mm - 1770mm sidewalls

**G** 2 x 735mm 'U' channels per side

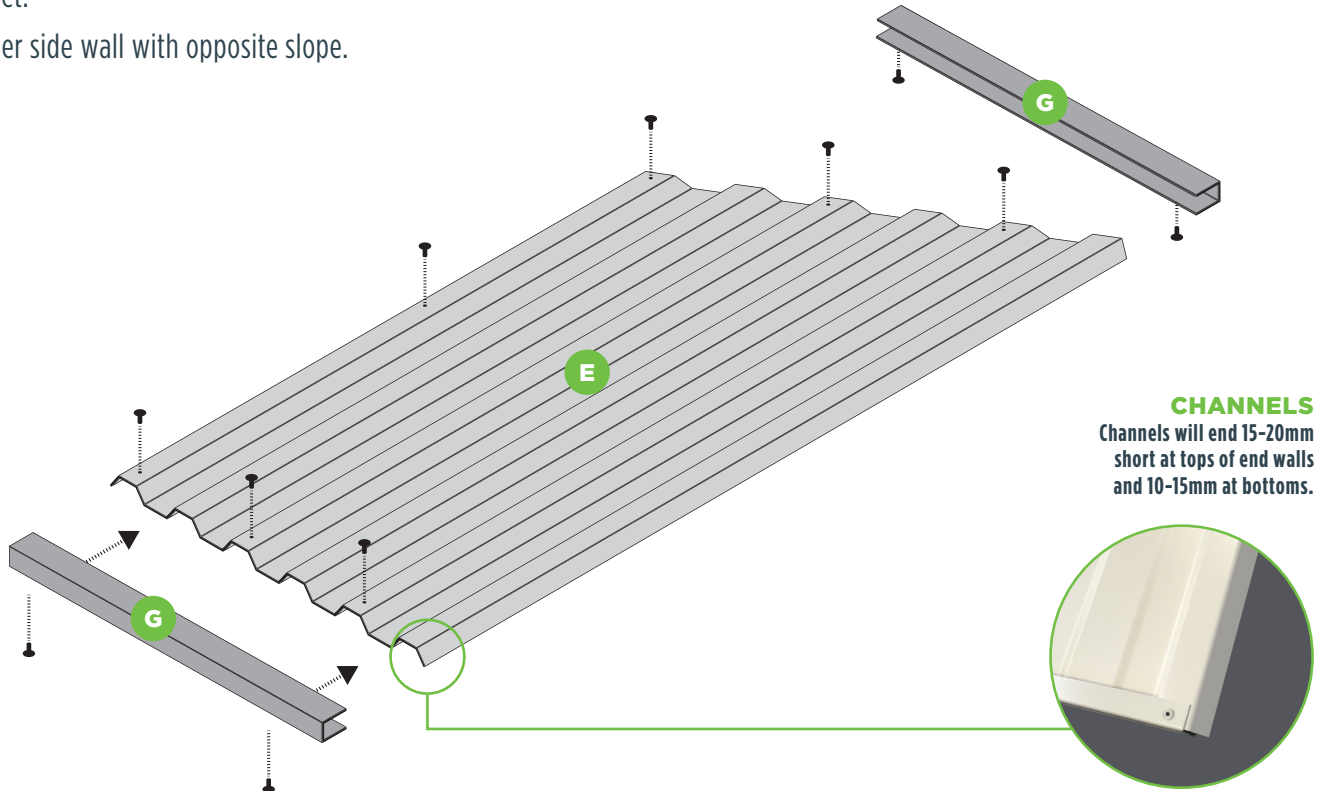

## STEP 7 DOOR BRACES

The door braces can be fitted now or after you have assembled your shed.

Tuck one end of the 'Z' between the bottom channel of the inside of the door and the sheet. Do the same at the top, overlapping in the centre behind the padbolt. If you have a locking 'T' handle you will have to run the 'Z's the opposite way to the diagram.

Rivet the 'Z's at the ends, and in the centre of the channel it is tucked under, and through the overlap in the centre. Two or three more fixings will be required through the door sheeting into the 'Z', but they will need to be riveted through from the outside of the door for a neater appearance.

You may need to cut or bend the flange at the bottom and the top of the 'Z' if it catches on the door jamb when opening or closing (diagram 1).

### YOU WILL NEED

**O** 2 x 'Z' Door braces

**N** Fixings

DIAGRAM 1

BEFORE

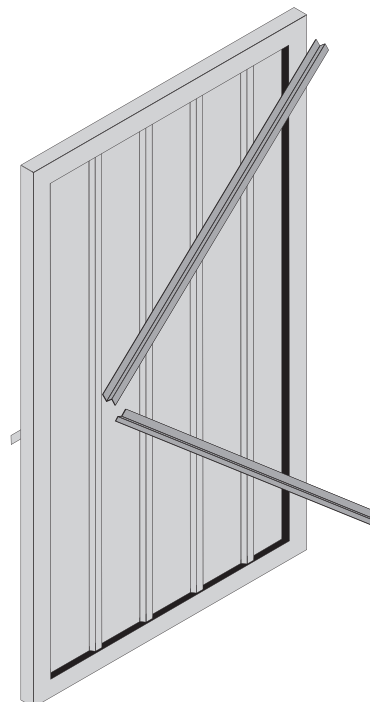
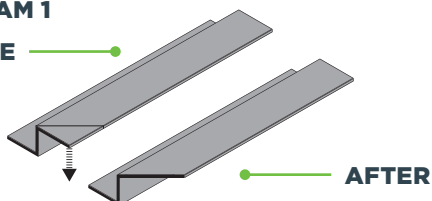



# STEP 8 INSTALLATION

## SIDE WALL ASSEMBLY

- Stand up the back wall and as your helping hand is holding it up, bring the left end wall in to meet it at the left corner (diagram 1) overlapping the corners (diagram 2). Drill and fix at approximately 100mm down from the top and up from the bottom, drilling and fixing from the outside.
- Bring the right end wall into the right back corner and perform the same again checking to make sure the walls are sitting flat at the bottom.
- Bring the front wall into place and join the front corners to the end walls, same as the back (diagram 3).
- Finish joining the corners by fixing at approximately 200-300mm apart. You will find it easier to drill these corners if they are supported on the inside (see tip).

## FIXING THE ROOF

- With a person at each end of the roof, lift it over the top of your upright walls and lower down on top with an overhang that looks best to you (diagram 4). At the left end fix through the 'L' flashing into the top channel of the left end wall. Measure the overhang at the back and fix the right end 'L' to the right end wall with the same overhang as the left end. If it is difficult to get the same overhang at each end, this will be caused by an unlevel site or walls that are not square. Adjust accordingly. Fix the 'L's at 300mm apart.
- Using the ladder and the tape measure, fix down through the top of the roof, through the pan into the top channel of the front and the back walls (10mm more than the overhang). Fix beside every second rib. You will not need to worry about these fixings leaking as any water seeping through these fixings will end up on the outside of the walls.

## FIT THE DOOR BRACES AND INSTALL SHED

- Fit the door braces, if not already done so. Check that all filings/swarf is removed.
- Important: Fix your shed down to its foundations. If your foundations are unlevel or bowed, you will have problems with your padbolt and door levels. This can be fixed by slipping a spade under either door jamb and lifting. You will soon get a feel for which side needs propping up.

## BUILDING YOUR SHED

The basic task is to join the sheets together to form your panels, and fix channels to the top and bottom of these panels.

They will then join together to form your shed (diagram 1, 2, 3 and 4).

DIAGRAM 1

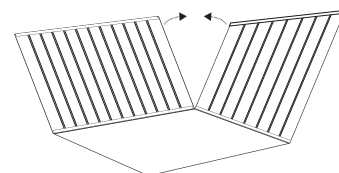

DIAGRAM 2

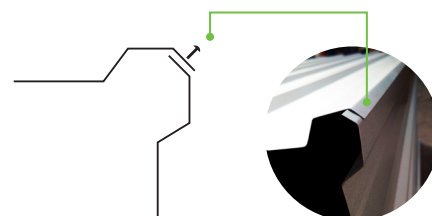

DIAGRAM 3

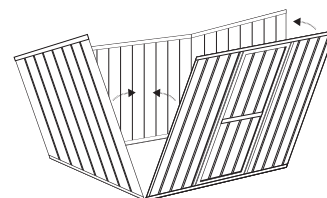
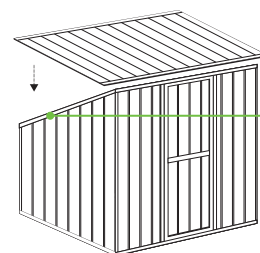
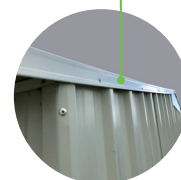

DIAGRAM 4



### L FLASHING

Rivet through the side of the 'L' flashing to secure the roof to the side of the shed.



## IMPORTANT

- Do not attempt to assemble panels in rain or windy conditions.
- Make sure your foundations are squared and level before erecting panels.
- It is easier to remove all swarf (filings) before you stand your walls up.
- Complete all panels before erecting your shed.
- Keep a firm grip on panels when handling. If they slip they will cause damage.
- Always wear non-slip gloves, protective footwear and eyewear.

## YOUR SHED'S FLOOR

- It is essential that every shed has a floor, but the only way to make sure your shed is there to stay on windy sites is with a recessed concrete floor.

## GALVO TIP

Use the handle end of a hammer in the inside of the corner, but beware of drilling holes on the end of your hammer!

# STEP 9 COMPLETE YOUR SHED

## RECESSED CONCRETE FLOOR PLAN FOR SPECIALLY POURED CONCRETE FLOORS: SPECIFICATIONS

Every shed must have some type of foundation between it and the ground. You can pour a concrete floor and use recessed floor clamps, use an existing concrete base with flat floor clamps or purchase a kitset wooden floor from your nearest reseller.

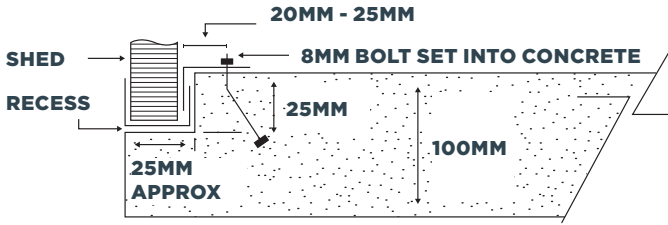

APPROX 25MM RECESS  
AROUND THE OUTSIDE

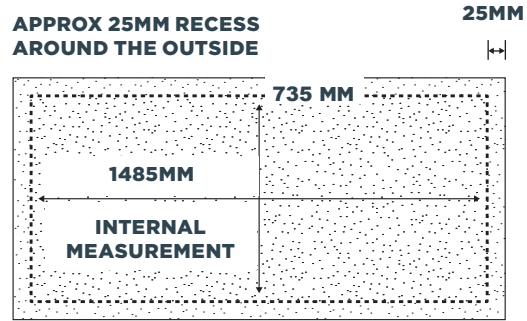

BOXING DIAGRAM

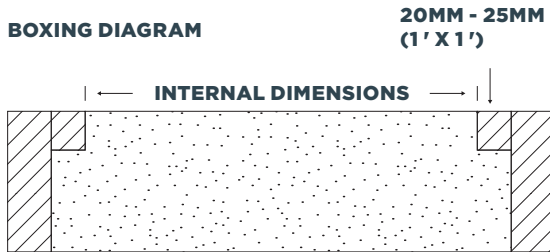

### RECESSED FLOOR CLAMPS

For poured floors with a recess around the perimeter.

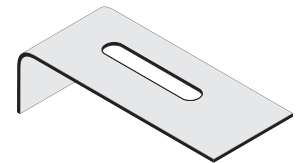

INTERNAL DIMENSIONS

**GVO  
1508**

**1485MM X 735MM**

### FLAT FLOOR CLAMPS

For existing concrete only. Water can seep underneath.

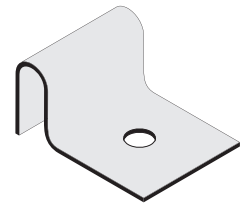

## KITSET WOODEN FLOORS

Every shed must have a floor. These are available from your local reseller or contact [info@storetech.nz](mailto:info@storetech.nz)

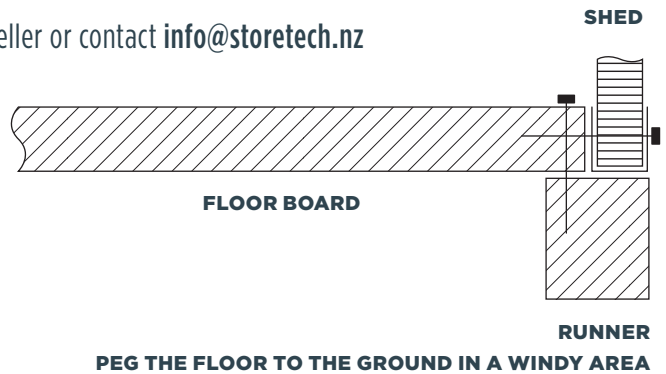
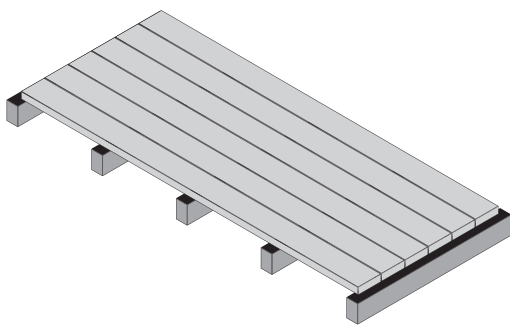

### WARRANTY

Thank you for purchasing a GALVO shed. We offer you a 15 Year warranty for Classic range and 18 Year warranty on the GALVO Premium range. The warranty is very simple - "if any part or component of your shed fails, we will send you a new part or component". Your GALVO shed will require very little maintenance unless it is situated near the sea/ocean or any other harsh environments e.g. sulphur, etc\* If your GALVO shed is situated near the sea or harsh environments we suggest you wash the shed regularly (every 3 months or less) to prolong the life of your shed. However the warranty that we offer will be overridden by the warranty/guarantee offered by the original manufacturer of the steel.

The conditions listed below apply and are applicable to the 15 and 18 year warranties:

(a) the warranty shall not cover any defect or damage which may be caused or partly caused by or arise through: (i) failure on the part of the Customer to properly maintain any Goods; or (ii) failure on the part of the Customer to follow any instructions or guidelines provided by the Supplier; or (iii) any use of any Goods otherwise than for any application specified on a quote or order form; or (iv) the continued use of any Goods after any defect becomes apparent or would have become apparent to a reasonably prudent operator or user; or (v) the storage of caustic materials (including but not limited to acids, fertilisers or hazardous chemicals); or (vi) Fair wear and tear, any accident or act of God. (including weather) (b) The warranty shall cease and the Supplier shall thereafter in no circumstances be liable under the terms of the warranty if the workmanship is repaired, altered or overhauled without the Supplier's consent. (c) in respect of all claims the Supplier shall not be liable to compensate the Customer for any delay in either replacing or remedying the workmanship or in properly assessing the Customer's claim. (d) Your shed must be raised above ground level (of natural earth substrate) by at least 70mm.

For Goods not manufactured by the Supplier, the warranty shall be the current warranty provided by the manufacturer of the Goods. The Supplier shall not be bound by nor be responsible for any term, condition, representation or warranty other than that which is given by the manufacturer of the Goods. Where the Supplier is required to perform labour associated with the replacement or repair of defective Goods under manufacturer's warranty, the labour performed shall be charged at the Supplier's hourly rate. We wish you many years of trouble free storage of your valuable assets and we would be only too happy to assist with any questions you may have. Email to [info@storetech.nz](mailto:info@storetech.nz)

The team at Storetech Industries Ltd, suppliers of GALVO sheds.

\*The GALVO Classic range is not covered by warranty within 2 kms of the sea or if it's situated in thermal regions, but is priced accordingly.

