



CEDARSHED INSTRUCTIONS

DOVER - COLOURSTEEL ROOF

Base size: 3600mm x 2775mm deep

DOVER

Tools Required:

- Battery Drill
- Riveter
- Hammer
- Tape Measure
- Ladder
- Skillsaw
- Level
- Screwdriver - Flat
- 3/8 Hex Drive bit
- 8mm Hex Drive bit
- Drill Bit 3.5mm
- Tin Snips
- Knife
- Drill Bit 12mm (Veranda and Deck)

IMPORTANT

SUNSCREEN WARNING: Prevent contact of the painted surface with sunscreens containing titanium dioxide (TiO₂) or zinc oxide (ZnO). It has been proven to discolour and degrade the paint finish. The use of gloves is recommended.

Damage to prepainted steel caused by contact with sunscreen is not covered by your Duratuf warranty.

Before you start:

- Read all instructions carefully.
- Identify all parts and check quantities against checklist.

Safety:

- Do not attempt to build your shed in high winds.
- Beware of sharp edges.
- Protect your eyes and ears.
- Use electric tools with care. Use a Safety Trip Switch.
- It is easier and quicker if this shed is erected by two people.

Select your site:

- Your shed must be level. Achieve this by either levelling the ground or by using blocks.

DOVER PARTS LIST

Description	Size	Qty	
Cabin with Plywood Floor			
Ranchslider	1820 x 1890	1	<input type="checkbox"/>
Standard Wall Panels	1200 x 2057	6	<input type="checkbox"/>
Gable Wall Panels	1342 x 2510	2	<input type="checkbox"/>
Gable Wall Panels (R/S)	1342 x 2510	2	<input type="checkbox"/>
Door Lintel	90 x 45 x 1800	1	<input type="checkbox"/>
Cedar Corner Clashings	65 x 17 x 2082	4	<input type="checkbox"/>
30 x 17 Std Cedarbead	30 x 17 x 2057	4	<input type="checkbox"/>
15 x 17 Std Cedarbead	15 x 17 x 2057	4	<input type="checkbox"/>
15 x 17 Slider Cedarbeads	15 x 17 x 1937	2	<input type="checkbox"/>
30 x 17 Gable Cedarbead	30 x 17 x 2510	1	<input type="checkbox"/>
30 x 17 Slider Gable Cedarbead	30 x 17 x 410	1	<input type="checkbox"/>
Roof Truss w/ Brackets	578 x 45 x 2775	1	<input type="checkbox"/>
Barge Flashings	1700mm	4	<input type="checkbox"/>
Building Paper	1370 x 12000	1	<input type="checkbox"/>
Roofing Sheets	875 x 1565	12	<input type="checkbox"/>
Ridge Flashing	240 x 2010	3	<input type="checkbox"/>
Purlins	70 x 45 x 1858	12	<input type="checkbox"/>
Stiffeners	45 x 45 x 3600	2	<input type="checkbox"/>
Spouting	3716mm	2	<input type="checkbox"/>
Lintel Flashing	1930mm	1	<input type="checkbox"/>
FIXINGS			
Tek Screws	14G x 75mm, CL4	50	<input type="checkbox"/>
Framing Nails	75 x 3.15mm	70	<input type="checkbox"/>
Bead Nails	50 x 2.5mm	90	<input type="checkbox"/>
Galv Clouts (Cladding Nails)	30 x 2.5mm	120	<input type="checkbox"/>
Colour Rivets	3.2 x 8.2mm	90	<input type="checkbox"/>
Roofing Screws and Washers	50mm	80	<input type="checkbox"/>
Silicone Tubes		3	<input type="checkbox"/>
Truss Bracket/Ranchslider Screws	8G x 40mm	12	<input type="checkbox"/>
Instructions		1	<input type="checkbox"/>
Plastic Weatherstrip	50mm x 20mtrs	1	<input type="checkbox"/>

Packed by:

Date: / /

DOVER PARTS LIST

Description	Size	Qty	
Floor Option			
Floor Joists	70 x 45 x 3590	2	<input type="checkbox"/>
Floor Joists	70 x 45 x 2675	7	<input type="checkbox"/>
Floor Joists	70 x 45 x 546	6	<input type="checkbox"/>
Plywood Flooring	1382 x 1200 x 17	4	<input type="checkbox"/>
Plywood Flooring	1382 x 1190 x 17	2	<input type="checkbox"/>
Floor Screws	8G x 40mm	100	<input type="checkbox"/>
Floor Joist Nails	90 x 3.15mm	60	<input type="checkbox"/>
Deck Option			
Deck Joists	70 x 45 x 2775	2	<input type="checkbox"/>
Deck Joists	70 x 45 x 990	6	<input type="checkbox"/>
Grip Tread Decking	90 x 19 x 2775	12	<input type="checkbox"/>
Floor Joist Nails	90 x 3.15mm	24	<input type="checkbox"/>
Decking Nails	50 x 2.5mm	144	<input type="checkbox"/>
Tek Screws	14G x 100mm	5	<input type="checkbox"/>
Packer H4	30 x 45 x 2775	1	<input type="checkbox"/>

Note: The Hardware is not separated by quantity per optional extra. Example - 90mm nails will be bagged as one rather than separated for Deck and Floor.

DOVER CONCRETE FLOOR - OPTIONAL

Building a Raised Concrete Base

Step 3: Establish size of shed and excavate sufficient area. Remember to allow for rear roof overhang up to 150mm, and 120mm on each end.

Step 4: Ensure that the base substrate is compacted firmly. We suggest that the slab should be 80mm thick in the middle and 100mm thick around the edges.

Step 5: Lay boxing to the required size, the raised slab size should be 3585 x 2760mm and at least 30mm above the ground line.

Step 6: Lay plastic sheeting if required. Plastic sheeting under slab will prevent moisture coming through from underneath.

Step 7: Pour concrete and screed flush

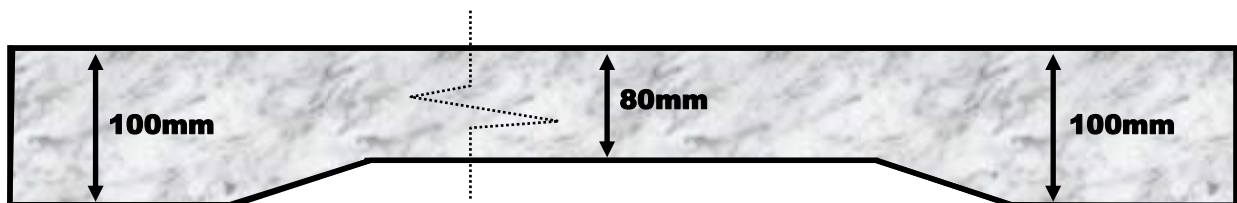

DOVER FLOOR - OPTIONAL

Step 1: Lay out floor joists, and assemble sub floor as shown below, nailing sub floor together with 90mm nails. Ensure joists are level and supported every 800mm. Check diagonals before screwing 6 sheets of 17mm ply to frame using 40mm screws as shown.

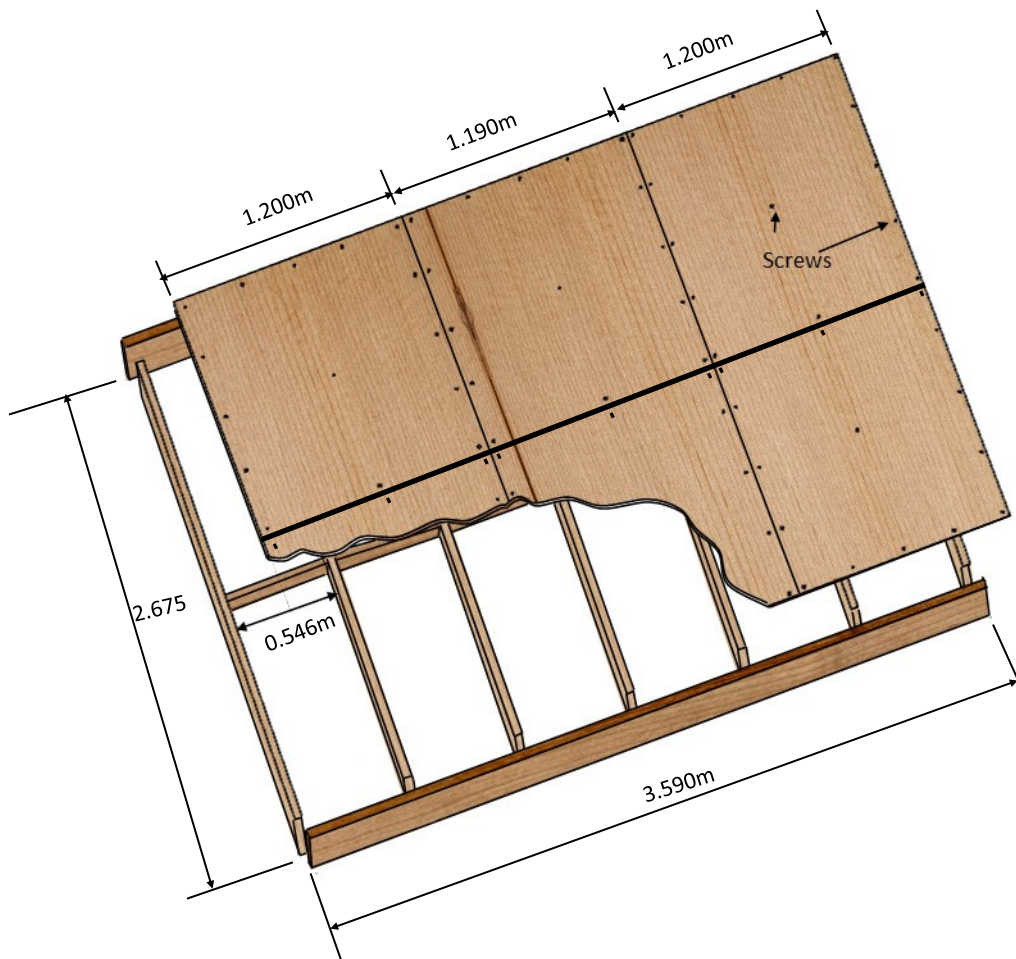

Step 2: Nail plastic weather strip to edge of floor on all four sides, with 30mm clouts, (approx 5 nails per side) ensuring top edge is flush with top of floor. This isn't required if shed is on a concrete base.



DOVER WALL PLAN

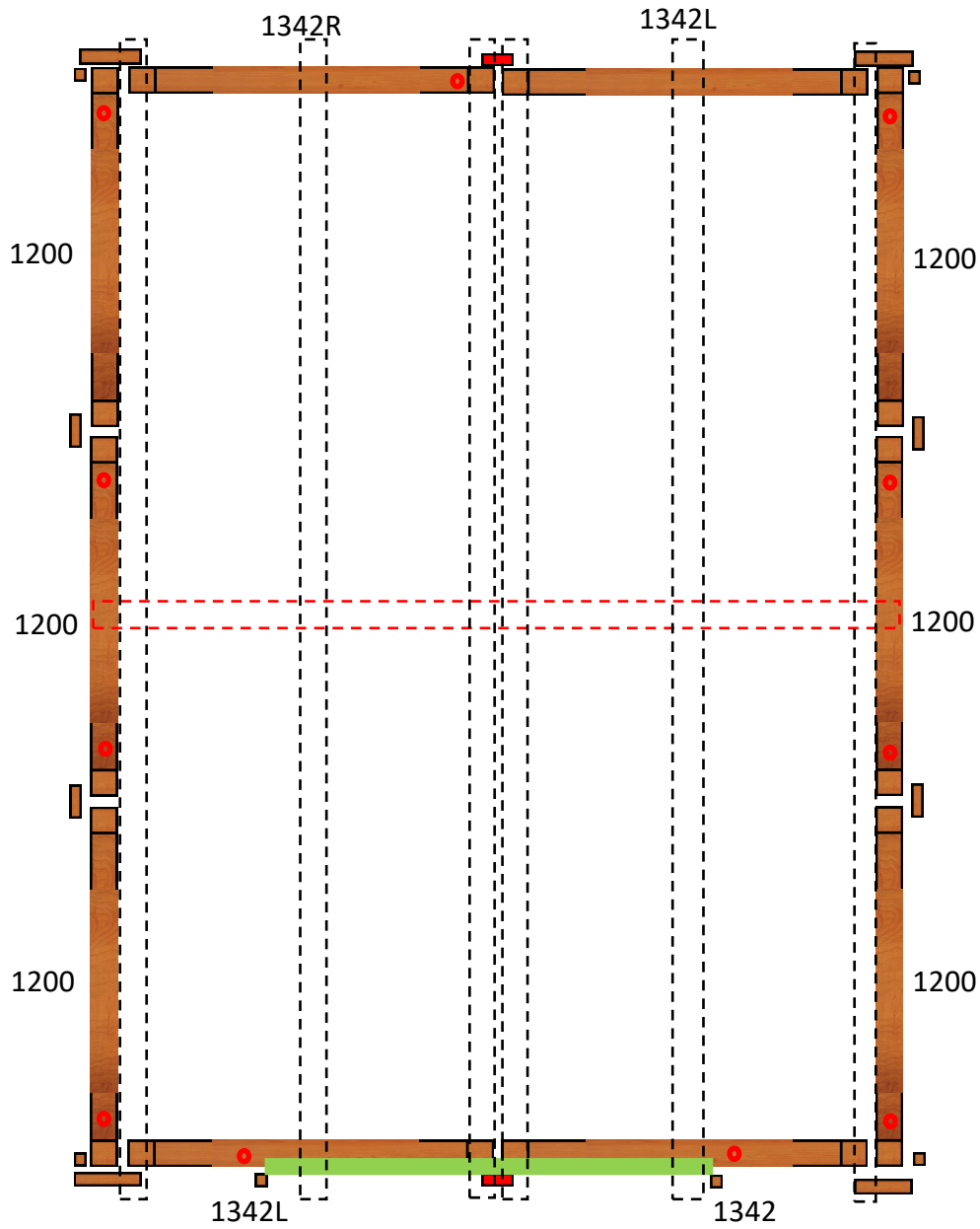

15 x 17mm Std Cedar bead



30 x 17mm Std Cedar bead



30 x 17mm Gable Cedar bead



Corner Clashing



Tek Screws Floor



Purlins



Truss



DOVER WALLS

Step 3: Unpack panels and identify wall panels and door positions as per plan on following page.

Select two panels that go either side of a corner (gable and standard panel) and stand together.



Step 4: Screw the two wall panels together using 75mm tek screws (3 per panel), ensuring Gable Wall Panels are inside the Back and Front Panels as per the wall plan.

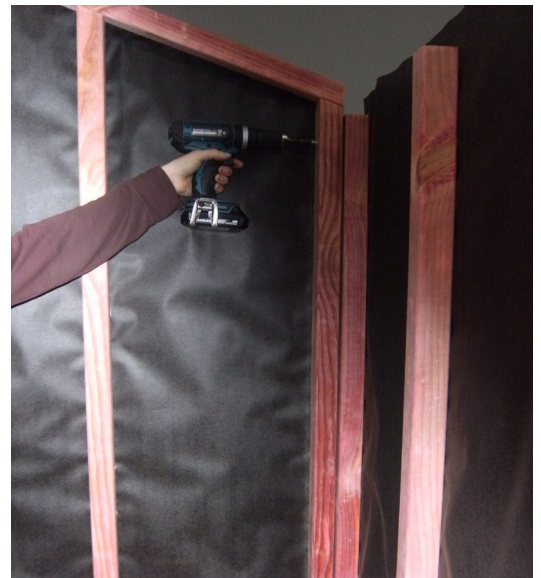

Step 5: Silicone edge of weatherboards on standing panels and nail on cedar beads with 5 x bead nails. (Refer to wall plan for correct beads).

Make sure bead is properly sealed to avoid leaks.

Note: The top of the bead is bevelled to allow for slope of roof.

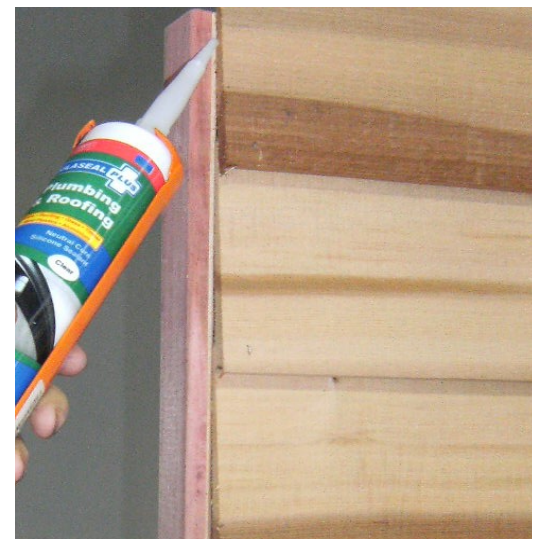

DOVER WALLS

Step 6: Silicone and nail remaining beads before erecting each panel.

Screw remaining panels together as per wall plan, using 3 Tek screws per join and 4 on the longer gable end panels.



DOVER TOP STIFFENER

Step 7: Using 75mm framing nails, nail both top plate stiffeners into standard wall panels studs, as shown using 2 nails per stud. Ensure ends are flush before nailing.



Step 8: Using 30mm clouts nail top cedar boards to stiffeners (2-3 nails per board). Pre-drill holes to stop boards from splitting.

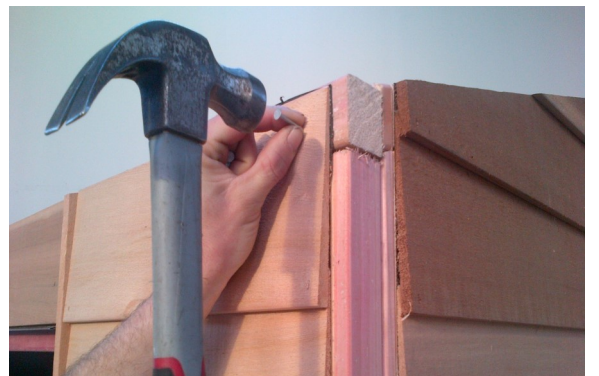

DOVER TOP LINTEL

Step 9: Using 4 x 75mm Tek screws screw door lintel to studs.

Door Lintel shown from inside



DOVER CORNER CLASHINGS

Step 10: Silicone and nail 15 x 17mm beads on all corners as shown using 5 x 50mm bead nails, per bead.



Step 11: Silicone and nail corner clashings on all corners as shown using 5 x bead nails per clashing.

Silicone both edges of clashing to ensure this doesn't leak.



DOVER RANCHSLIDER

Step 12: Silicone around the 2 sides and top of door opening before placing ranch slider in position.



Using 40mm screws, screw Ranch slider to the wall panels each side, 3 screws per side. Place Lintel flashing centrally over ranchslider and predrill 3mm holes to nail through the weatherboard and flashing to the studs.



Step 13: Check all wall panels are straight. Measure diagonals to ensure measurements are equal (i.e. floor is square).

Screw panels to floor using 75mm tek screws and the wall plan as a guide for correct positions. Start with the four corners, then screw walls ensuring walls are straight.

Screw near the panel joins, where possible.

DOVER ROOF

Step 14: Position roof truss in centre of the side walls. Using 4 x 40mm screws, screw truss to top plate stiffeners.



Step 15: Position 12 purlins on roof. Top purlins should be together and bottom purlins should be against top plate. Using 75mm framing nails, predrill then nail purlins into top of gable end panels and truss (2 nails per join).



The Veranda Purlins will extend beyond the wall by approximately 1100mm.

DOVER ROOF

Step 16: Ensure shed is square, by measuring diagonals at top corner of wall panels. Using 30mm clouts, nail building paper on to purlins. Bend up the top end of pans on roof sheets for added weather protection using roofing pliers .

Step 17: Position first full sheet with rib flush with ends of purlins and top of sheet in the centre of roof. (So sheets touch in the middle).

Tack top of the sheet into the top purlin using a 30mm clout through the pan. Using a 50mm Roofing Screw with Washer, screw through the rib into the bottom purlin to a depth of approximately 10mm.



Note. Use 50mm Roofing screws with washers for bottom purlin and 30mm clouts for top purlin. Predrill holes for clear roof panels.

DOVER ROOF

Step 18: Lay out remaining full roof sheets and 1/2 sheet. Rivet these sheets together, 2 rivets per joint, to make 1 large roof panel as shown in photo. Tack remaining top corner and bottom corner ensuring edge of sheet is flush with end of purlins and height is correct.

Ensure purlins are straight, Nail through the panel using 30mm clouts into the top purlin, using 50mm roofing screws with washers screw through the rib into the bottom purlin.

Step 19: Rivet ridge flashing to roof on every second rib, as shown.



Model shown is Bentley shed



DOVER BARGE

Step 20: Attach barges with rivets as required. Place front and back spouting on and rivet to roof sheets, (1 rivet every 2 ribs)

Barges will need to be cut to correct length and top cut to correct angle.

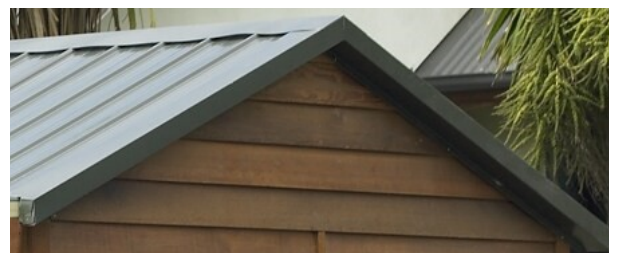

Remember to remove all drill filings from your colour steel roof.

Your shed is now complete. You may protect Cedar by staining cedar weatherboards if required.

DOVER DECK- OPTIONAL

Step 21 :Lay out Deck joists and assemble sub floor as shown below, nailing sub floor together with 90mm nails. Place 30 x 45mm packer between sub floor and shed floor then attach sub floor to shed floor, with 5 x 100mm tek screws. Check subfloor is level and diagonals are correct before nailing 12 lengths of grip tread to frame using 50mm nails as shown. You may need to rip last length of grip tread to suit.

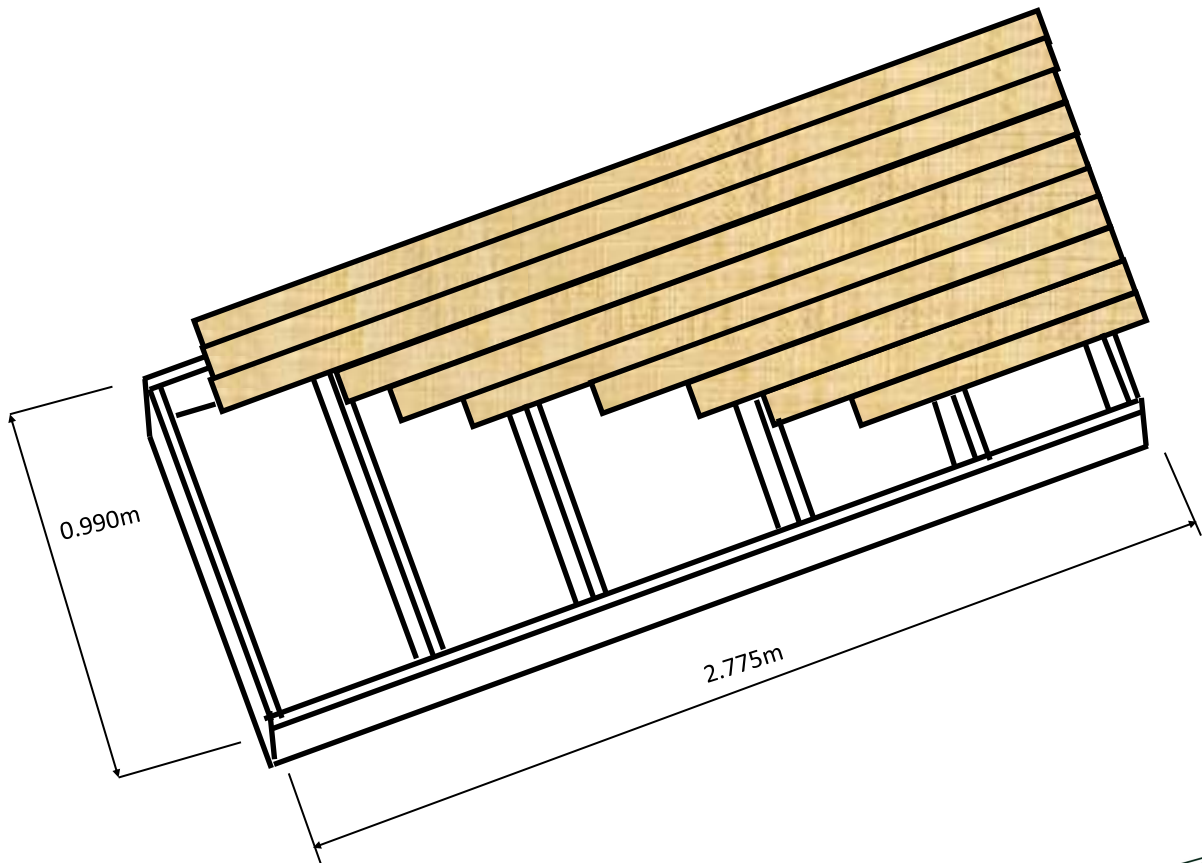

CEDAR SHED WARRANTY

GUARANTEE TO CUSTOMER

Congratulations on purchasing a quality New Zealand made Cedar Shed manufactured by Riverlea Group Limited. With proper care and attention this product will offer you many years of use.

WARRANTY ON METAL CLADDING

Your new shed is guaranteed for the benefit of the original purchaser, against defective material or faulty workmanship for **fifteen years** from date of purchase. Riverlea Group Limited will, at its discretion, replace or repair any faulty or defective materials within this time on condition that due care and maintenance has been carried out as detailed below.

TERMS AND CONDITIONS

This warranty does not cover Cedar sheds with steel roofing if it is installed outside the inland corrosion zone or areas where the corrosion rate is more than 200g/m² (as published by BRANZ)

1. The warranty does not cover damage or failure due to improper assembly.
2. This warranty does not cover damage through force majeure or other cause beyond the control of Riverlea Group Limited.
3. This warranty is void if maintenance as detailed below and in the assembly manual has not been adhered to.
4. This warranty does not cover natural variations, expansion, contractions as can be reasonably expected from a timber product.

Painting or coating of your Cedar Shed with a dark colour will cause increased timber temperature and movement which will render this warranty null and void.

Beyond the exclusions above, Riverlea Group Limited will repair or replace the damaged or faulty product. The balance of the original warranty will cover any repaired or replaced material. Riverlea Group Limited will not be liable for any consequential loss or damage, labour or transport costs. All claims must be made within 21 days of discovery.

MAINTENANCE

The following are the minimum maintenance requirements for Cedar Sheds manufactured by Riverlea Group Limited. Please refer to your assembly manual for more details.

Immediately coat all cedar walling cladding with "Endurance Cedar Wall Protector". Cedar walls are to be regularly recoated according to application instructions on the product packaging.

Immediately coat all cedar shingle roofing with "Endurance Cedar Shingle Protector" Cedar shingles are to be regularly recoated according to application instructions on the product packaging.

All steel roofing is to be kept clean and free of debris and washed annually with a hose and soft brush.

Timber floors, where supplied are to be kept out of direct water contact or runoff

The above guidelines will guarantee you a superior Cedar Shed that will offer you many years of outstanding usefulness.

WARRANTY REGISTRATION

Please visit <http://www.riverleagroup.co.nz/warranty-garden-sheds> to validate the Warranty on your shed.

Click on the Warranty Registration Link and complete all details.

If you are unable to access the computer, please phone us on 0800 438 274 and one of the customer services team will help you to activate the warranty on your garden shed.

Many thanks, from the Team at Riverlea Group.

